



SIRIUS soft starter 200-480 V 315 A, 24 V AC/DC Screw terminals Analog output











product brand name	SIRIUS
product category	Hybrid switching devices
product designation	Soft starter
product type designation	3RW52
manufacturer's article number	<ul style="list-style-type: none"> • of standard HMI module usable 3RW5980-0HS00 • of high feature HMI module usable 3RW5980-0HF00 • of communication module PROFINET standard usable 3RW5980-0CS00 • of communication module PROFIBUS usable 3RW5980-0CP00 • of communication module Modbus TCP usable 3RW5980-0CT00 • of communication module Modbus RTU usable 3RW5980-0CR00 • of communication module Ethernet/IP 3RW5980-0CE00 • of circuit breaker usable at 400 V 3VA2440-7MN32-0AA0: Type of coordination 1, Iq = 65 kA, CLASS 10 • of circuit breaker usable at 500 V 3VA2440-7MN32-0AA0: Type of coordination 1, Iq = 65 kA, CLASS 10 • of circuit breaker usable at 400 V at inside-delta circuit 3VA2580-6HN32-0AA0: Type of coordination 1, Iq = 65 kA, CLASS 10 • of circuit breaker usable at 500 V at inside-delta circuit 3VA2580-6HN32-0AA0: Type of coordination 1, Iq = 65 kA, CLASS 10 • of the gG fuse usable up to 690 V 2x3NA3365-6; Type of coordination 1, Iq = 65 kA • of the gG fuse usable at inside-delta circuit up to 500 V 2x3NA3365-6; Type of coordination 1, Iq = 65 kA • of full range R fuse link for semiconductor protection usable up to 690 V 3NE1334-2: Type of coordination 2, Iq = 65 kA • of back-up R fuse link for semiconductor protection usable up to 690 V 3NE3336: Type of coordination 2, Iq = 65 kA
General technical data	
starting voltage [%]	30 ... 100 %
stopping voltage [%]	50 ... 50 %
start-up ramp time of soft starter	0 ... 20 s
current limiting value [%] adjustable	130 ... 700 %
certificate of suitability	<ul style="list-style-type: none"> • CE marking Yes • UL approval Yes • CSA approval Yes
product component is supported	<ul style="list-style-type: none"> • HMI-Standard Yes • HMI-High Feature Yes
product feature integrated bypass contact system	Yes

number of controlled phases	3
trip class	CLASS 10A (default) / 10E / 20E; acc. to IEC 60947-4-2
buffering time in the event of power failure	
• for main current circuit	100 ms
• for control circuit	100 ms
insulation voltage rated value	600 V
degree of pollution	3, acc. to IEC 60947-4-2
impulse voltage rated value	6 kV
blocking voltage of the thyristor maximum	1 600 V
service factor	1
surge voltage resistance rated value	6 kV
maximum permissible voltage for safe isolation	
• between main and auxiliary circuit	600 V
shock resistance	15 g / 11 ms, from 12 g / 11 ms with potential contact lifting
vibration resistance	15 mm to 6 Hz; 2g to 500 Hz
utilization category acc. to IEC 60947-4-2	AC 53a
reference code acc. to IEC 81346-2	Q
Substance Prohibitance (Date)	15.02.2018 00:00:00
product function	
• ramp-up (soft starting)	Yes
• ramp-down (soft stop)	Yes
• Soft Torque	Yes
• adjustable current limitation	Yes
• pump ramp down	Yes
• intrinsic device protection	Yes
• motor overload protection	Yes; Electronic motor overload protection
• evaluation of thermistor motor protection	No
• inside-delta circuit	Yes
• auto-RESET	Yes
• manual RESET	Yes
• remote reset	Yes; By turning off the control supply voltage
• communication function	Yes
• operating measured value display	Yes; Only in conjunction with special accessories
• error logbook	Yes; Only in conjunction with special accessories
• via software parameterizable	No
• via software configurable	Yes
• PROFInergy	Yes; in connection with the PROFINET Standard communication module
• firmware update	Yes
• removable terminal for control circuit	Yes
• torque control	No
• analog output	Yes; 4 ... 20 mA (default) / 0 ... 10 V (parameterizable with High Feature HMI)
Power Electronics	
operational current	
• at 40 °C rated value	315 A
• at 50 °C rated value	279 A
• at 60 °C rated value	255 A
operational current at inside-delta circuit	
• at 40 °C rated value	546 A
• at 50 °C rated value	483 A
• at 60 °C rated value	442 A
operating voltage	
• rated value	200 ... 480 V
• at inside-delta circuit rated value	200 ... 480 V
relative negative tolerance of the operating voltage	-15 %
relative positive tolerance of the operating voltage	10 %
relative negative tolerance of the operating voltage at inside-delta circuit	-15 %

relative positive tolerance of the operating voltage at inside-delta circuit	10 %
operating power for 3-phase motors	
• at 230 V at 40 °C rated value	90 kW
• at 230 V at inside-delta circuit at 40 °C rated value	160 kW
• at 400 V at 40 °C rated value	160 kW
• at 400 V at inside-delta circuit at 40 °C rated value	315 kW
Operating frequency 1 rated value	50 Hz
Operating frequency 2 rated value	60 Hz
relative negative tolerance of the operating frequency	-10 %
relative positive tolerance of the operating frequency	10 %
adjustable motor current	
• at rotary coding switch on switch position 1	135 A
• at rotary coding switch on switch position 2	147 A
• at rotary coding switch on switch position 3	159 A
• at rotary coding switch on switch position 4	171 A
• at rotary coding switch on switch position 5	183 A
• at rotary coding switch on switch position 6	195 A
• at rotary coding switch on switch position 7	207 A
• at rotary coding switch on switch position 8	219 A
• at rotary coding switch on switch position 9	231 A
• at rotary coding switch on switch position 10	243 A
• at rotary coding switch on switch position 11	255 A
• at rotary coding switch on switch position 12	267 A
• at rotary coding switch on switch position 13	279 A
• at rotary coding switch on switch position 14	291 A
• at rotary coding switch on switch position 15	303 A
• at rotary coding switch on switch position 16	315 A
• minimum	135 A
adjustable motor current	
• for inside-delta circuit at rotary coding switch on switch position 1	234 A
• for inside-delta circuit at rotary coding switch on switch position 2	255 A
• for inside-delta circuit at rotary coding switch on switch position 3	275 A
• for inside-delta circuit at rotary coding switch on switch position 4	296 A
• for inside-delta circuit at rotary coding switch on switch position 5	317 A
• for inside-delta circuit at rotary coding switch on switch position 6	338 A
• for inside-delta circuit at rotary coding switch on switch position 7	359 A
• for inside-delta circuit at rotary coding switch on switch position 8	379 A
• for inside-delta circuit at rotary coding switch on switch position 9	400 A
• for inside-delta circuit at rotary coding switch on switch position 10	421 A
• for inside-delta circuit at rotary coding switch on switch position 11	442 A
• for inside-delta circuit at rotary coding switch on switch position 12	462 A
• for inside-delta circuit at rotary coding switch on switch position 13	483 A
• for inside-delta circuit at rotary coding switch on switch position 14	504 A
• for inside-delta circuit at rotary coding switch on switch position 15	525 A
• for inside-delta circuit at rotary coding switch on switch position 16	546 A

<ul style="list-style-type: none"> at inside-delta circuit minimum 	234 A
minimum load [%]	15 %; Relative to smallest settable I _e
power loss [W] for rated value of the current at AC	
<ul style="list-style-type: none"> at 40 °C after startup 	107 W
<ul style="list-style-type: none"> at 50 °C after startup 	96 W
<ul style="list-style-type: none"> at 60 °C after startup 	89 W
power loss [W] at AC at current limitation 350 %	
<ul style="list-style-type: none"> at 40 °C during startup 	5 350 W
<ul style="list-style-type: none"> at 50 °C during startup 	4 471 W
<ul style="list-style-type: none"> at 60 °C during startup 	3 934 W
Control circuit/ Control	
type of voltage of the control supply voltage	AC/DC
control supply voltage at AC	
<ul style="list-style-type: none"> at 50 Hz rated value 	24 V
<ul style="list-style-type: none"> at 60 Hz rated value 	24 V
relative negative tolerance of the control supply voltage at AC at 50 Hz	-20 %
relative positive tolerance of the control supply voltage at AC at 50 Hz	20 %
relative negative tolerance of the control supply voltage at AC at 60 Hz	-20 %
relative positive tolerance of the control supply voltage at AC at 60 Hz	20 %
control supply voltage frequency	50 ... 60 Hz
relative negative tolerance of the control supply voltage frequency	-10 %
relative positive tolerance of the control supply voltage frequency	10 %
control supply voltage	
<ul style="list-style-type: none"> at DC rated value 	24 V
relative negative tolerance of the control supply voltage at DC	-20 %
relative positive tolerance of the control supply voltage at DC	20 %
control supply current in standby mode rated value	160 mA
holding current in bypass operation rated value	470 mA
locked-rotor current at close of bypass contact maximum	7.6 A
inrush current peak at application of control supply voltage maximum	3.3 A
duration of inrush current peak at application of control supply voltage	12.1 ms
design of the overvoltage protection	Varistor
design of short-circuit protection for control circuit	4 A gG fuse (I _{cu} =1 kA), 6 A quick-acting fuse (I _{cu} =1 kA), C1 miniature circuit breaker (I _{cu} = 600 A), C6 miniature circuit breaker (I _{cu} = 300 A); Is not part of scope of supply
Inputs/ Outputs	
number of digital inputs	1
number of inputs for thermistor connection	0
number of digital outputs	3
<ul style="list-style-type: none"> not parameterizable 	2
digital output version	2 normally-open contacts (NO) / 1 changeover contact (CO)
number of analog outputs	1
switching capacity current of the relay outputs	
<ul style="list-style-type: none"> at AC-15 at 250 V rated value 	3 A
<ul style="list-style-type: none"> at DC-13 at 24 V rated value 	1 A
Installation/ mounting/ dimensions	
mounting position	with vertical mounting surface +/-90° rotatable, with vertical mounting surface +/- 22.5° tiltable to the front and back
fastening method	screw fixing
height	393 mm

width	210 mm
depth	203 mm
required spacing with side-by-side mounting	
<ul style="list-style-type: none"> • forwards • backwards • upwards • downwards • at the side 	10 mm 0 mm 100 mm 75 mm 5 mm
weight without packaging	9.9 kg
Connections/ Terminals	
type of electrical connection	
<ul style="list-style-type: none"> • for main current circuit • for control circuit 	busbar connection screw-type terminals
width of connection bar maximum	45 mm
type of connectable conductor cross-sections	
<ul style="list-style-type: none"> • for DIN cable lug for main contacts stranded • for DIN cable lug for main contacts finely stranded 	2x (50 ... 240 mm ²) 2x (70 ... 240 mm ²)
type of connectable conductor cross-sections	
<ul style="list-style-type: none"> • for control circuit solid • for control circuit finely stranded with core end processing • at AWG cables for control circuit solid 	1x (0.5 ... 4.0 mm ²), 2x (0.5 ... 2.5 mm ²) 1x (0.5 ... 2.5 mm ²), 2x (0.5 ... 1.5 mm ²) 1x (20 ... 12), 2x (20 ... 14)
wire length	
<ul style="list-style-type: none"> • between soft starter and motor maximum • at the digital inputs at AC maximum • at the digital inputs at DC maximum 	800 m 100 m 1 000 m
tightening torque	
<ul style="list-style-type: none"> • for main contacts with screw-type terminals • for auxiliary and control contacts with screw-type terminals 	14 ... 24 N·m 0.8 ... 1.2 N·m
tightening torque [lbf·in]	
<ul style="list-style-type: none"> • for main contacts with screw-type terminals • for auxiliary and control contacts with screw-type terminals 	124 ... 210 lbf·in 7 ... 10.3 lbf·in
Ambient conditions	
installation altitude at height above sea level maximum	5 000 m; Derating as of 1000 m, see catalog
ambient temperature	
<ul style="list-style-type: none"> • during operation • during storage and transport 	-25 ... +60 °C; Please observe derating at temperatures of 40 °C or above -40 ... +80 °C
environmental category	
<ul style="list-style-type: none"> • during operation acc. to IEC 60721 • during storage acc. to IEC 60721 • during transport acc. to IEC 60721 	3K6 (no ice formation, only occasional condensation), 3C3 (no salt mist), 3S2 (sand must not get into the devices), 3M6 1K6 (only occasional condensation), 1C2 (no salt mist), 1S2 (sand must not get inside the devices), 1M4 2K2, 2C1, 2S1, 2M2 (max. fall height 0.3 m)
EMC emitted interference	acc. to IEC 60947-4-2: Class A
Communication/ Protocol	
communication module is supported	
<ul style="list-style-type: none"> • PROFINET standard • EtherNet/IP • Modbus RTU • Modbus TCP • PROFIBUS 	Yes Yes Yes Yes Yes
UL/CSA ratings	
manufacturer's article number	
<ul style="list-style-type: none"> • of circuit breaker <ul style="list-style-type: none"> — usable for Standard Faults at 460/480 V according to UL 	Siemens type: 3VA53, max. 400 A or 3VA54, max. 600 A; I _q = 18 kA

<ul style="list-style-type: none"> — usable for High Faults at 460/480 V according to UL — usable for Standard Faults at 460/480 V at inside-delta circuit according to UL — usable for High Faults at 460/480 V at inside-delta circuit according to UL — usable for Standard Faults at 575/600 V according to UL — usable for Standard Faults at 575/600 V at inside-delta circuit according to UL 	<p>Siemens type: 3VA53, max. 400 A or 3VA54, max. 600 A; Iq max = 65 kA</p> <p>Siemens type: 3VA54, max. 600 A; Iq = 18 kA</p>				
<ul style="list-style-type: none"> • of the fuse <ul style="list-style-type: none"> — usable for Standard Faults up to 575/600 V according to UL — usable for High Faults up to 575/600 V according to UL — usable for Standard Faults at inside-delta circuit up to 575/600 V according to UL — usable for High Faults at inside-delta circuit up to 575/600 V according to UL 	<p>Siemens type: 3VA54, max. 600 A; Iq max = 65 kA</p> <p>Siemens type: 3VA53, max. 400 A or 3VA54, max. 600 A; Iq = 18 kA</p> <p>Siemens type: 3VA54, max. 600 A; Iq = 18 kA</p> <p>Type: Class J / L, max. 1000 A; Iq = 18 kA</p> <p>Type: Class J / L, max. 1000 A; Iq = 100 kA</p> <p>Type: Class J / L, max. 1000 A; Iq = 18 kA</p> <p>Type: Class J / L, max. 1000 A; Iq = 100 kA</p>				
<p>operating power [hp] for 3-phase motors</p> <ul style="list-style-type: none"> • at 200/208 V at 50 °C rated value • at 220/230 V at 50 °C rated value • at 460/480 V at 50 °C rated value • at 200/208 V at inside-delta circuit at 50 °C rated value • at 220/230 V at inside-delta circuit at 50 °C rated value • at 460/480 V at inside-delta circuit at 50 °C rated value 	<p>75 hp</p> <p>100 hp</p> <p>200 hp</p> <p>150 hp</p> <p>200 hp</p> <p>400 hp</p>				
<p>contact rating of auxiliary contacts according to UL</p>	<p>R300-B300</p>				
Safety related data					
<p>protection class IP on the front acc. to IEC 60529</p>	<p>IP00; IP20 with cover</p>				
<p>touch protection on the front acc. to IEC 60529</p>	<p>finger-safe, for vertical contact from the front with cover</p>				
<p>electromagnetic compatibility</p>	<p>in accordance with IEC 60947-4-2</p>				
Certificates/ approvals					
General Product Approval	EMC	Declaration of Conformity			
 CSA	 CCC	 UL	 EAC	 RCM	 EG-Konf.
Test Certificates	Marine / Shipping				
Type Test Certificates/Test Report	 ABS	 BUREAU VERITAS	 LRS	 PRS	 DNV GL
other					
<p>Confirmation</p>					
Further information					
<p>Information- and Downloadcenter (Catalogs, Brochures,...)</p>					

<https://www.siemens.com/ic10>

Industry Mall (Online ordering system)

<https://mall.industry.siemens.com/mall/en/en/Catalog/product?mlfb=3RW5245-6AC04>

Cax online generator

<http://support.automation.siemens.com/WW/CAXorder/default.aspx?lang=en&mlfb=3RW5245-6AC04>

Service&Support (Manuals, Certificates, Characteristics, FAQs,...)

<https://support.industry.siemens.com/cs/ww/en/ps/3RW5245-6AC04>

Image database (product images, 2D dimension drawings, 3D models, device circuit diagrams, EPLAN macros, ...)

http://www.automation.siemens.com/bilddb/cax_de.aspx?mlfb=3RW5245-6AC04&lang=en

Characteristic: Tripping characteristics, I^t, Let-through current

<https://support.industry.siemens.com/cs/ww/en/ps/3RW5245-6AC04/char>

Characteristic: Installation altitude

<http://www.automation.siemens.com/bilddb/index.aspx?view=Search&mlfb=3RW5245-6AC04&objecttype=14&gridview=view1>

Simulation Tool for Soft Starters (STS)

<https://support.industry.siemens.com/cs/ww/en/view/101494917>

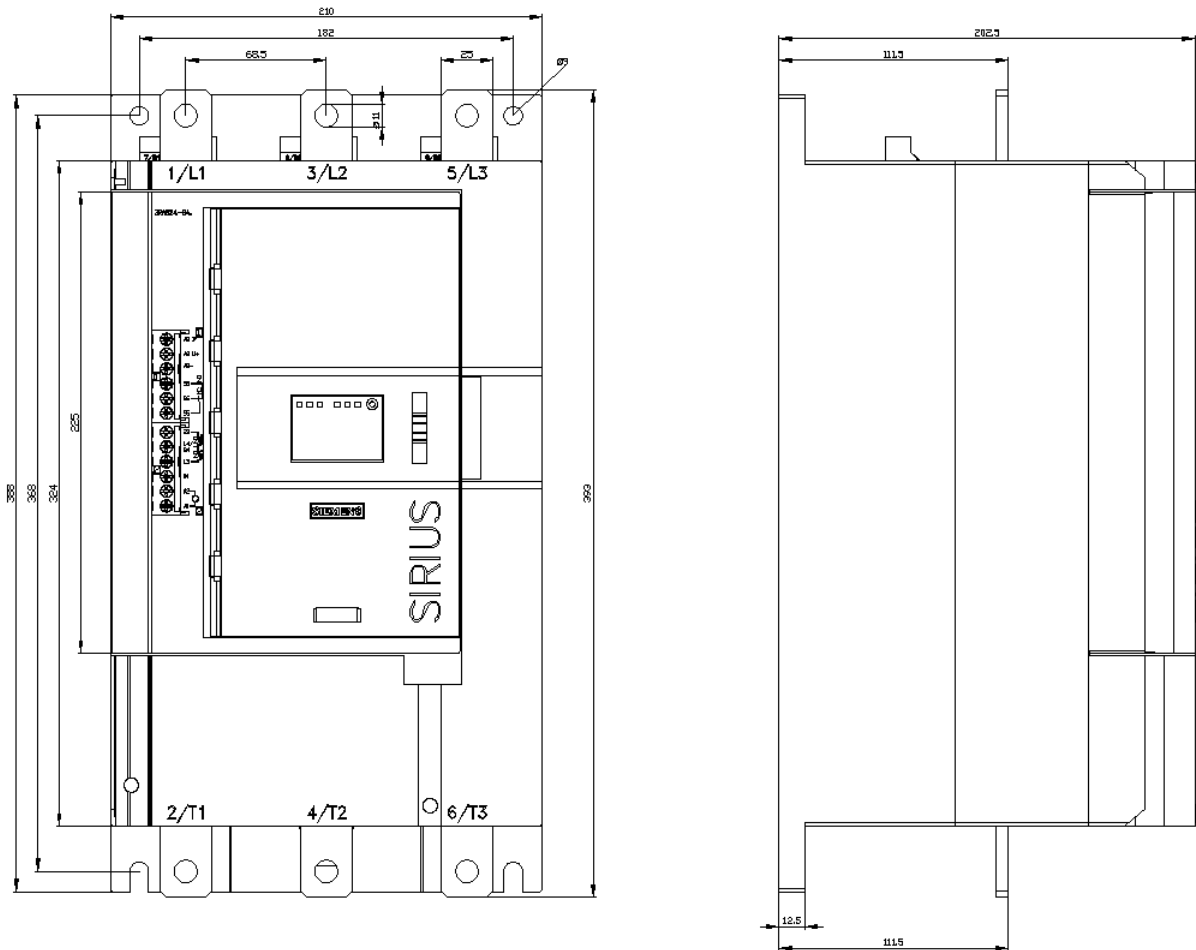

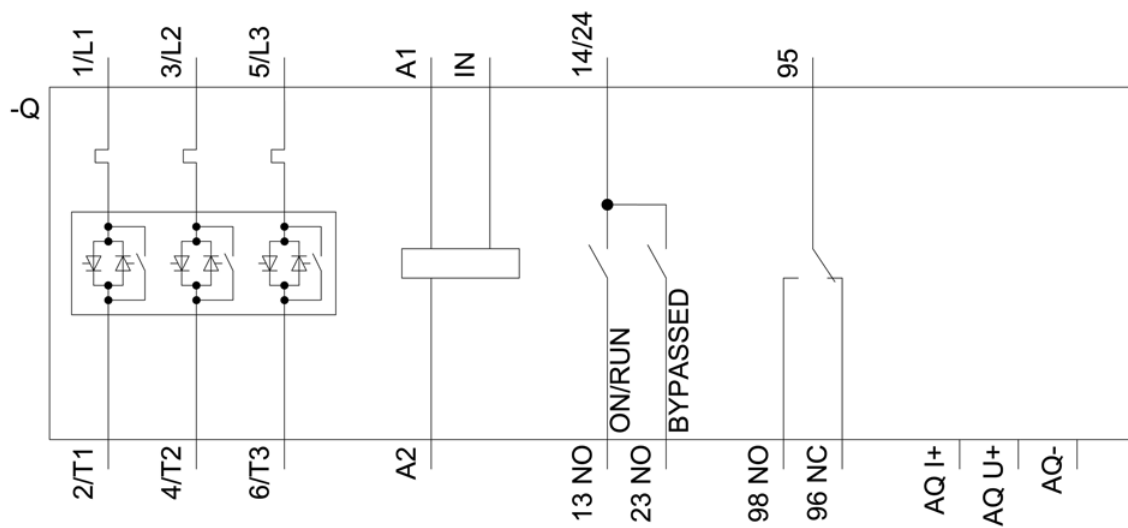

last modified:

12/15/2020 