



SIRIUS soft starter 200-600 V 13 A, 24 V AC/DC Screw terminals
Thermistor input











product brand name	SIRIUS
product category	Hybrid switching devices
product designation	Soft starter
product type designation	3RW52
manufacturer's article number	<ul style="list-style-type: none"> • of standard HMI module usable 3RW5980-0HS00 • of high feature HMI module usable 3RW5980-0HF00 • of communication module PROFINET standard usable 3RW5980-0CS00 • of communication module PROFIBUS usable 3RW5980-0CP00 • of communication module Modbus TCP usable 3RW5980-0CT00 • of communication module Modbus RTU usable 3RW5980-0CR00 • of communication module Ethernet/IP 3RW5980-0CE00 • of circuit breaker usable at 400 V 3RV2032-4TA10: Type of coordination 1, Iq = 65 kA, CLASS 10 • of circuit breaker usable at 500 V 3RV2032-4TA10: Type of coordination 1, Iq = 18 kA, CLASS 10 • of circuit breaker usable at 400 V at inside-delta circuit 3RV2032-4DA10: Type of coordination 1, Iq = 65 kA, CLASS 10 • of circuit breaker usable at 500 V at inside-delta circuit 3RV2032-4DA10: Type of coordination 1, Iq = 18 kA, CLASS 10 • of the gG fuse usable up to 690 V 3NA3820-6: Type of coordination 1, Iq = 65 kA • of the gG fuse usable at inside-delta circuit up to 500 V 3NA3820-6: Type of coordination 1, Iq = 65 kA • of full range R fuse link for semiconductor protection usable up to 690 V 3NE1815-0: Type of coordination 2, Iq = 65 kA • of back-up R fuse link for semiconductor protection usable up to 690 V 3NE8017-1: Type of coordination 2, Iq = 65 kA
General technical data	
starting voltage [%]	30 ... 100 %
stopping voltage [%]	50 ... 50 %
start-up ramp time of soft starter	0 ... 20 s
current limiting value [%] adjustable	130 ... 700 %
certificate of suitability	<ul style="list-style-type: none"> • CE marking Yes • UL approval Yes • CSA approval Yes
product component is supported	<ul style="list-style-type: none"> • HMI-Standard Yes • HMI-High Feature Yes
product feature integrated bypass contact system	Yes

number of controlled phases	3
trip class	CLASS 10A (default) / 10E / 20E; acc. to IEC 60947-4-2
buffering time in the event of power failure	
• for main current circuit	100 ms
• for control circuit	100 ms
insulation voltage rated value	600 V
degree of pollution	3, acc. to IEC 60947-4-2
impulse voltage rated value	6 kV
blocking voltage of the thyristor maximum	1 600 V
service factor	1
surge voltage resistance rated value	6 kV
maximum permissible voltage for safe isolation	
• between main and auxiliary circuit	600 V
shock resistance	15 g / 11 ms, from 12 g / 11 ms with potential contact lifting
vibration resistance	15 mm to 6 Hz; 2g to 500 Hz
utilization category acc. to IEC 60947-4-2	AC 53a
reference code acc. to IEC 81346-2	Q
Substance Prohibitance (Date)	15.02.2018 00:00:00
product function	
• ramp-up (soft starting)	Yes
• ramp-down (soft stop)	Yes
• Soft Torque	Yes
• adjustable current limitation	Yes
• pump ramp down	Yes
• intrinsic device protection	Yes
• motor overload protection	Yes; Full motor protection (thermistor motor protection and electronic motor overload protection)
• evaluation of thermistor motor protection	Yes; Type A PTC or Klixon / Thermoclick
• inside-delta circuit	Yes
• auto-RESET	Yes
• manual RESET	Yes
• remote reset	Yes; By turning off the control supply voltage
• communication function	Yes
• operating measured value display	Yes; Only in conjunction with special accessories
• error logbook	Yes; Only in conjunction with special accessories
• via software parameterizable	No
• via software configurable	Yes
• PROFenergy	Yes; in connection with the PROFINET Standard communication module
• firmware update	Yes
• removable terminal for control circuit	Yes
• torque control	No
• analog output	No
Power Electronics	
operational current	
• at 40 °C rated value	13 A
• at 50 °C rated value	12 A
• at 60 °C rated value	11 A
operational current at inside-delta circuit	
• at 40 °C rated value	22.5 A
• at 50 °C rated value	19.9 A
• at 60 °C rated value	18.2 A
operating voltage	
• rated value	200 ... 600 V
• at inside-delta circuit rated value	200 ... 600 V
relative negative tolerance of the operating voltage	-15 %
relative positive tolerance of the operating voltage	10 %
relative negative tolerance of the operating voltage at inside-delta circuit	-15 %

relative positive tolerance of the operating voltage at inside-delta circuit	10 %
operating power for 3-phase motors	
• at 230 V at 40 °C rated value	3 kW
• at 230 V at inside-delta circuit at 40 °C rated value	5.5 kW
• at 400 V at 40 °C rated value	5.5 kW
• at 400 V at inside-delta circuit at 40 °C rated value	11 kW
• at 500 V at 40 °C rated value	7.5 kW
• at 500 V at inside-delta circuit at 40 °C rated value	15 kW
Operating frequency 1 rated value	50 Hz
Operating frequency 2 rated value	60 Hz
relative negative tolerance of the operating frequency	-10 %
relative positive tolerance of the operating frequency	10 %
adjustable motor current	
• at rotary coding switch on switch position 1	5.5 A
• at rotary coding switch on switch position 2	6 A
• at rotary coding switch on switch position 3	6.5 A
• at rotary coding switch on switch position 4	7 A
• at rotary coding switch on switch position 5	7.5 A
• at rotary coding switch on switch position 6	8 A
• at rotary coding switch on switch position 7	8.5 A
• at rotary coding switch on switch position 8	9 A
• at rotary coding switch on switch position 9	9.5 A
• at rotary coding switch on switch position 10	10 A
• at rotary coding switch on switch position 11	10.5 A
• at rotary coding switch on switch position 12	11 A
• at rotary coding switch on switch position 13	11.5 A
• at rotary coding switch on switch position 14	12 A
• at rotary coding switch on switch position 15	12.5 A
• at rotary coding switch on switch position 16	13 A
• minimum	5.5 A
adjustable motor current	
• for inside-delta circuit at rotary coding switch on switch position 1	9.5 A
• for inside-delta circuit at rotary coding switch on switch position 2	10.4 A
• for inside-delta circuit at rotary coding switch on switch position 3	11.3 A
• for inside-delta circuit at rotary coding switch on switch position 4	12.1 A
• for inside-delta circuit at rotary coding switch on switch position 5	13 A
• for inside-delta circuit at rotary coding switch on switch position 6	13.9 A
• for inside-delta circuit at rotary coding switch on switch position 7	14.7 A
• for inside-delta circuit at rotary coding switch on switch position 8	15.6 A
• for inside-delta circuit at rotary coding switch on switch position 9	16.5 A
• for inside-delta circuit at rotary coding switch on switch position 10	17.3 A
• for inside-delta circuit at rotary coding switch on switch position 11	18.2 A
• for inside-delta circuit at rotary coding switch on switch position 12	19.1 A
• for inside-delta circuit at rotary coding switch on switch position 13	19.9 A
• for inside-delta circuit at rotary coding switch on switch position 14	20.8 A
• for inside-delta circuit at rotary coding switch on switch position 15	21.7 A

<ul style="list-style-type: none"> • for inside-delta circuit at rotary coding switch on switch position 16 	22.5 A
<ul style="list-style-type: none"> • at inside-delta circuit minimum 	9.5 A
minimum load [%]	15 %; Relative to smallest settable le
power loss [W] for rated value of the current at AC	
<ul style="list-style-type: none"> • at 40 °C after startup 	16 W
<ul style="list-style-type: none"> • at 50 °C after startup 	15 W
<ul style="list-style-type: none"> • at 60 °C after startup 	15 W
power loss [W] at AC at current limitation 350 %	
<ul style="list-style-type: none"> • at 40 °C during startup 	210 W
<ul style="list-style-type: none"> • at 50 °C during startup 	178 W
<ul style="list-style-type: none"> • at 60 °C during startup 	161 W
Control circuit/ Control	
type of voltage of the control supply voltage	AC/DC
control supply voltage at AC	
<ul style="list-style-type: none"> • at 50 Hz rated value 	24 V
<ul style="list-style-type: none"> • at 60 Hz rated value 	24 V
relative negative tolerance of the control supply voltage at AC at 50 Hz	-20 %
relative positive tolerance of the control supply voltage at AC at 50 Hz	20 %
relative negative tolerance of the control supply voltage at AC at 60 Hz	-20 %
relative positive tolerance of the control supply voltage at AC at 60 Hz	20 %
control supply voltage frequency	50 ... 60 Hz
relative negative tolerance of the control supply voltage frequency	-10 %
relative positive tolerance of the control supply voltage frequency	10 %
control supply voltage	
<ul style="list-style-type: none"> • at DC rated value 	24 V
relative negative tolerance of the control supply voltage at DC	-20 %
relative positive tolerance of the control supply voltage at DC	20 %
control supply current in standby mode rated value	160 mA
holding current in bypass operation rated value	360 mA
locked-rotor current at close of bypass contact maximum	0.75 A
inrush current peak at application of control supply voltage maximum	3.3 A
duration of inrush current peak at application of control supply voltage	12.1 ms
design of the overvoltage protection	Varistor
design of short-circuit protection for control circuit	4 A gG fuse (I _{cu} =1 kA), 6 A quick-acting fuse (I _{cu} =1 kA), C1 miniature circuit breaker (I _{cu} = 600 A), C6 miniature circuit breaker (I _{cu} = 300 A); Is not part of scope of supply
Inputs/ Outputs	
number of digital inputs	1
number of inputs for thermistor connection	1; Type A PTC or Klixon / Thermoclick
number of digital outputs	3
<ul style="list-style-type: none"> • not parameterizable 	2
digital output version	2 normally-open contacts (NO) / 1 changeover contact (CO)
number of analog outputs	0
switching capacity current of the relay outputs	
<ul style="list-style-type: none"> • at AC-15 at 250 V rated value 	3 A
<ul style="list-style-type: none"> • at DC-13 at 24 V rated value 	1 A
Installation/ mounting/ dimensions	
mounting position	+/- 10° rotation possible and can be tilted forward or backward on vertical mounting surface
fastening method	screw fixing

height	275 mm
width	170 mm
depth	152 mm
required spacing with side-by-side mounting	
<ul style="list-style-type: none"> • forwards 	10 mm
<ul style="list-style-type: none"> • backwards 	0 mm
<ul style="list-style-type: none"> • upwards 	100 mm
<ul style="list-style-type: none"> • downwards 	75 mm
<ul style="list-style-type: none"> • at the side 	5 mm
weight without packaging	2.1 kg
Connections/ Terminals	
type of electrical connection	
<ul style="list-style-type: none"> • for main current circuit 	screw-type terminals
<ul style="list-style-type: none"> • for control circuit 	screw-type terminals
wire length for thermistor connection	
<ul style="list-style-type: none"> • with conductor cross-section = 0.5 mm² maximum 	50 m
<ul style="list-style-type: none"> • with conductor cross-section = 1.5 mm² maximum 	150 m
<ul style="list-style-type: none"> • with conductor cross-section = 2.5 mm² maximum 	250 m
type of connectable conductor cross-sections	
<ul style="list-style-type: none"> • for main contacts <ul style="list-style-type: none"> — solid 	2x (1.0 ... 2.5 mm ²), 2x (2.5 ... 10 mm ²)
<ul style="list-style-type: none"> <ul style="list-style-type: none"> — finely stranded with core end processing 	2x (1.0 ... 2.5 mm ²), 2x (2.5 ... 6.0 mm ²)
<ul style="list-style-type: none"> • at AWG cables for main current circuit solid 	2x (16 ... 12), 2x (14 ... 8)
type of connectable conductor cross-sections	
<ul style="list-style-type: none"> • for control circuit solid 	1x (0.5 ... 4.0 mm ²), 2x (0.5 ... 2.5 mm ²)
<ul style="list-style-type: none"> • for control circuit finely stranded with core end processing 	1x (0.5 ... 2.5 mm ²), 2x (0.5 ... 1.5 mm ²)
<ul style="list-style-type: none"> • at AWG cables for control circuit solid 	1x (20 ... 12), 2x (20 ... 14)
wire length	
<ul style="list-style-type: none"> • between soft starter and motor maximum 	800 m
<ul style="list-style-type: none"> • at the digital inputs at AC maximum 	100 m
<ul style="list-style-type: none"> • at the digital inputs at DC maximum 	1 000 m
tightening torque	
<ul style="list-style-type: none"> • for main contacts with screw-type terminals 	2 ... 2.5 N·m
<ul style="list-style-type: none"> • for auxiliary and control contacts with screw-type terminals 	0.8 ... 1.2 N·m
tightening torque [lbf·in]	
<ul style="list-style-type: none"> • for main contacts with screw-type terminals 	18 ... 22 lbf·in
<ul style="list-style-type: none"> • for auxiliary and control contacts with screw-type terminals 	7 ... 10.3 lbf·in
Ambient conditions	
installation altitude at height above sea level maximum	5 000 m; Derating as of 1000 m, see catalog
ambient temperature	
<ul style="list-style-type: none"> • during operation 	-25 ... +60 °C; Please observe derating at temperatures of 40 °C or above
<ul style="list-style-type: none"> • during storage and transport 	-40 ... +80 °C
environmental category	
<ul style="list-style-type: none"> • during operation acc. to IEC 60721 	3K6 (no ice formation, only occasional condensation), 3C3 (no salt mist), 3S2 (sand must not get into the devices), 3M6
<ul style="list-style-type: none"> • during storage acc. to IEC 60721 	1K6 (only occasional condensation), 1C2 (no salt mist), 1S2 (sand must not get inside the devices), 1M4
<ul style="list-style-type: none"> • during transport acc. to IEC 60721 	2K2, 2C1, 2S1, 2M2 (max. fall height 0.3 m)
EMC emitted interference	acc. to IEC 60947-4-2: Class A
Communication/ Protocol	
communication module is supported	
<ul style="list-style-type: none"> • PROFINET standard 	Yes
<ul style="list-style-type: none"> • EtherNet/IP 	Yes
<ul style="list-style-type: none"> • Modbus RTU 	Yes
<ul style="list-style-type: none"> • Modbus TCP 	Yes

• PROFIBUS	Yes	
UL/CSA ratings		
manufacturer's article number		
<ul style="list-style-type: none"> • of circuit breaker <ul style="list-style-type: none"> — usable for Standard Faults at 460/480 V according to UL — usable for High Faults at 460/480 V according to UL — usable for Standard Faults at 460/480 V at inside-delta circuit according to UL — usable for High Faults at 460/480 V at inside-delta circuit according to UL — usable for Standard Faults at 575/600 V according to UL — usable for Standard Faults at 575/600 V at inside-delta circuit according to UL • of the fuse <ul style="list-style-type: none"> — usable for Standard Faults up to 575/600 V according to UL — usable for High Faults up to 575/600 V according to UL — usable for Standard Faults at inside-delta circuit up to 575/600 V according to UL — usable for High Faults at inside-delta circuit up to 575/600 V according to UL 	<p>Siemens type: 3RV2742, max. 40 A or 3VA51, max. 40 A; Iq = 5 kA</p> <p>Siemens type: 3RV2742, max. 30 A or 3VA51, max. 35 A; Iq max = 65 kA</p> <p>Siemens type: 3RV2742, max. 40 A or 3VA51, max. 40 A; Iq = 5 kA</p> <p>Siemens type: 3RV2742, max. 30 A or 3VA51, max. 35 A; Iq max = 65 kA</p> <p>Siemens type: 3RV2742, max. 40 A or 3VA51, max. 40 A; Iq = 5 kA</p> <p>Siemens type: 3RV2742, max. 40 A or 3VA51, max. 40 A; Iq = 5 kA</p> <p>Type: Class RK5 / K5, max. 50 A; Iq = 5 kA</p> <p>Type: Class J / L, max. 50 A; Iq = 100 kA</p> <p>Type: Class RK5 / K5, max. 50 A; Iq = 5 kA</p> <p>Type: Class J / L, max. 50 A; Iq = 100 kA</p>	
operating power [hp] for 3-phase motors		
<ul style="list-style-type: none"> • at 200/208 V at 50 °C rated value • at 220/230 V at 50 °C rated value • at 460/480 V at 50 °C rated value • at 575/600 V at 50 °C rated value • at 200/208 V at inside-delta circuit at 50 °C rated value • at 220/230 V at inside-delta circuit at 50 °C rated value • at 460/480 V at inside-delta circuit at 50 °C rated value • at 575/600 V at inside-delta circuit at 50 °C rated value 	<p>2 hp</p> <p>3 hp</p> <p>7.5 hp</p> <p>10 hp</p> <p>5 hp</p> <p>5 hp</p> <p>10 hp</p> <p>15 hp</p>	
contact rating of auxiliary contacts according to UL	R300-B300	
Safety related data		
protection class IP on the front acc. to IEC 60529	IP20	
touch protection on the front acc. to IEC 60529	finger-safe, for vertical contact from the front	
electromagnetic compatibility	in accordance with IEC 60947-4-2	
Certificates/ approvals		
General Product Approval	EMC	Declaration of Conformity
     		
Test Certificates	Marine / Shipping	
Type Test Certificates/Test Report	    	
other		

Further information

Information- and Downloadcenter (Catalogs, Brochures,...)

<https://www.siemens.com/ic10>

Industry Mall (Online ordering system)

<https://mall.industry.siemens.com/mall/en/en/Catalog/product?mlfb=3RW5213-1TC05>

Cax online generator

<http://support.automation.siemens.com/WW/CAXorder/default.aspx?lang=en&mlfb=3RW5213-1TC05>

Service&Support (Manuals, Certificates, Characteristics, FAQs,...)

<https://support.industry.siemens.com/cs/ww/en/ps/3RW5213-1TC05>

Image database (product images, 2D dimension drawings, 3D models, device circuit diagrams, EPLAN macros, ...)

http://www.automation.siemens.com/bilddb/cax_de.aspx?mlfb=3RW5213-1TC05&lang=en

Characteristic: Tripping characteristics, I^t, Let-through current

<https://support.industry.siemens.com/cs/ww/en/ps/3RW5213-1TC05/char>

Characteristic: Installation altitude

<http://www.automation.siemens.com/bilddb/index.aspx?view=Search&mlfb=3RW5213-1TC05&objecttype=14&gridview=view1>

Simulation Tool for Soft Starters (STS)

<https://support.industry.siemens.com/cs/ww/en/view/101494917>

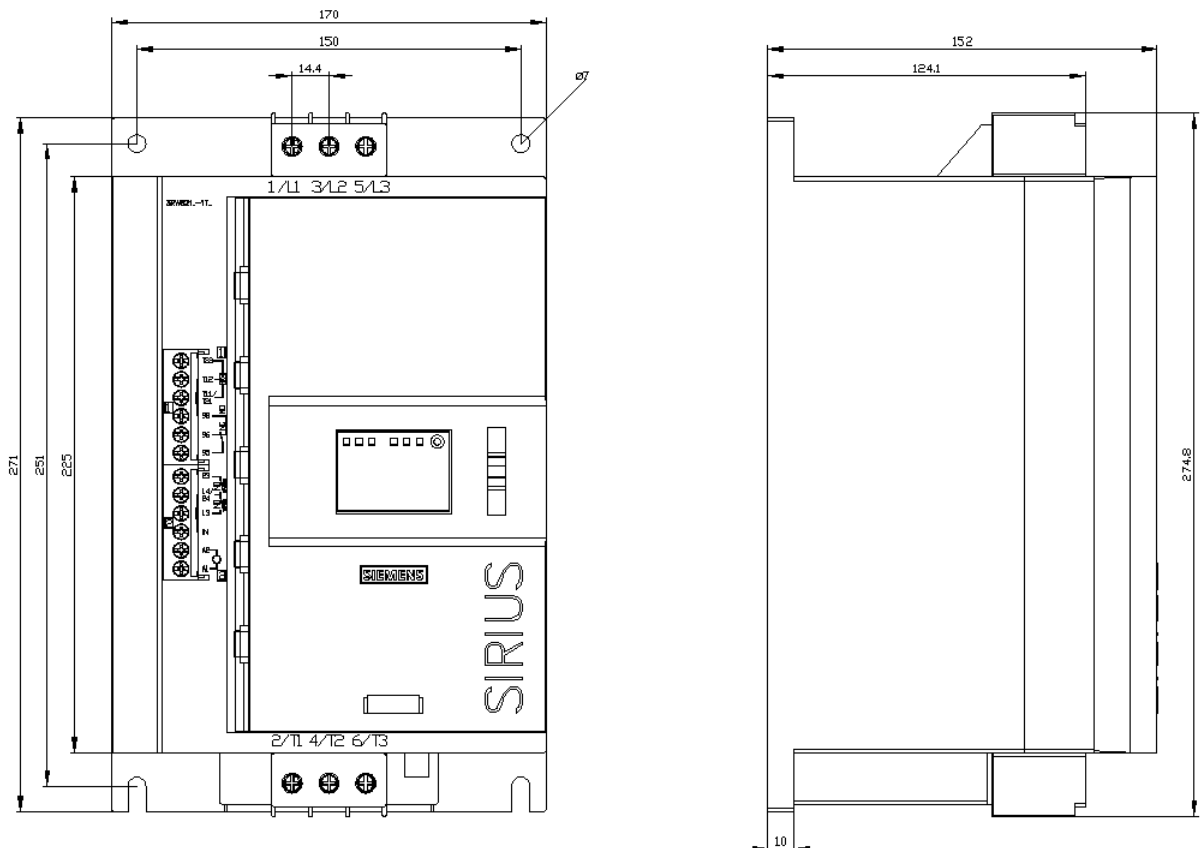

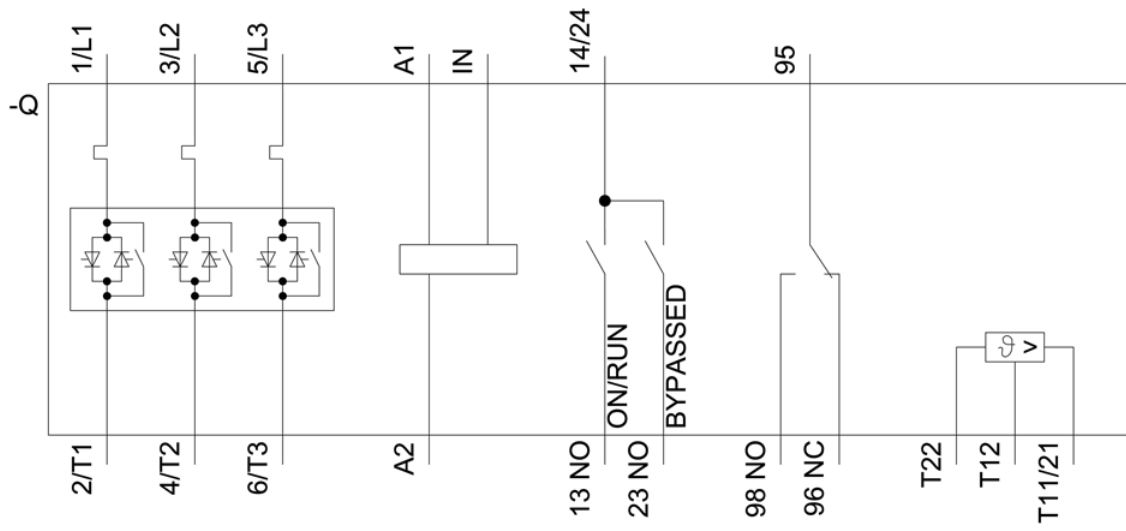

last modified:

8/10/2021 