

# ATS01N209QN

soft starter for asynchronous motor - ATS01 - 9 A - 380..415 V - 4 KW

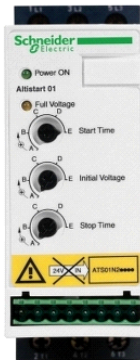

## Main

Range of product	Altistart 01
Product or component type	Soft starter
Product destination	Asynchronous motors
Product specific application	Simple machine
Device short name	ATS01
Network number of phases	3 phases
[Us] rated supply voltage	380...415 V - 10...10 %
Motor power kW	4 kW 3 phases 380...415 V
IcL starter rating	9 A
Utilisation category	AC-53B EN/IEC 60947-4-2
Current consumption	45 A at nominal load
Type of start	Start with voltage ramp
Power dissipation in W	4 W at full load and at end of starting 94 W in transient state

## Complementary

Assembly style	With heat sink
Function available	Integrated bypass
Supply voltage limits	342...456 V
Supply frequency	50...60 Hz - 5...5 %
Network frequency	47.5...63 Hz
Output voltage	<= power supply voltage
[Uc] control circuit voltage	Built into the starter
Starting time	Adjustable from 1 to 10 s 1 s 100 10 s 10 5 s 20
Deceleration time symb	Adjustable from 1 to 10 s
Starting torque	30...80 % of starting torque of motor connected directly on the line supply
Discrete input type	Logic LI1, LI2, BOOST stop, run and boost on start-up functions <= 8 mA 27 kOhm
Discrete input voltage	24...40 V
Discrete input logic	Positive LI1, LI2, BOOST < 5 V and <= 0.2 mA > 13 V >= 0.5 mA
Discrete output current	2 A DC-13 3 A AC-15
Discrete output type	Open collector logic LO1 end of starting signal Relay outputs R1A, R1C NO
Discrete output voltage	24 V 6...30 V open collector logic
Minimum switching current	10 mA 6 V DC relay outputs
Maximum switching current	2 A 250 V AC inductive cos phi = 0.5 20 ms relay outputs 2 A 30 V DC inductive cos phi = 0.5 20 ms relay outputs
Display type	1 LED green starter powered up 1 LED yellow nominal voltage reached
Tightening torque	0.5 N.m 1.9...2.5 N.m
Electrical connection	4 mm screw clamp terminal rigid 1 1...10 mm <sup>2</sup> AWG 8 power circuit Screw connector rigid 1 0.5...2.5 mm <sup>2</sup> AWG 14 control circuit 4 mm screw clamp terminal rigid 2 1...6 mm <sup>2</sup> AWG 10 power circuit Screw connector rigid 2 0.5...1 mm <sup>2</sup> AWG 17 control circuit Screw connector flexible with cable end 1 0.5...1.5 mm <sup>2</sup> AWG 16 control circuit 4 mm screw clamp terminal flexible without cable end 1 1.5...10 mm <sup>2</sup> AWG 8 power circuit Screw connector flexible without cable end 1 0.5...2.5 mm <sup>2</sup> AWG 14 control circuit

The information provided in this documentation contains general descriptions and/or technical characteristics of the performance of the products contained herein. This documentation is not intended as a substitute for and is not to be used for determining suitability or reliability of these products for specific user applications. It is the duty of any such user or integrator to perform the appropriate and complete risk analysis, evaluation and testing of the products with respect to the relevant specific application or use thereof. Neither Schneider Electric Industries SAS nor any of its affiliates or subsidiaries shall be responsible or liable for misuse of the information contained herein.

4 mm screw clamp terminal flexible with cable end 2 1...6 mm<sup>2</sup> AWG 10 power circuit  
 4 mm screw clamp terminal flexible without cable end 2 1.5...6 mm<sup>2</sup> AWG 10 power circuit  
 Screw connector flexible without cable end 2 0.5...1.5 mm<sup>2</sup> AWG 16 control circuit

Marking	CE
Operating position	Vertical +/- 10 degree
Height	124 mm
Width	45 mm
Depth	131 mm
Product weight	0.42 kg
Compatibility code	ATS01N2
Power range	4...6 kW at 380...440 V 3 phases
Motor starter type	Soft starter

## Environment

electromagnetic compatibility	EMC immunity EN 50082-1 Damped oscillating waves level 3 IEC 61000-4-12 Electrostatic discharge level 3 IEC 61000-4-2 Immunity to electrical transients level 4 IEC 61000-4-4 Immunity to radiated radio-electrical interference level 3 IEC 61000-4-3 Voltage/current impulse level 3 IEC 61000-4-5 Conducted and radiated emissions level B CISPR 11 Conducted and radiated emissions level B IEC 60947-4-2 EMC immunity EN 50082-2 Harmonics IEC 1000-3-2 Harmonics IEC 1000-3-4 Immunity to conducted interference caused by radio-electrical fields level 3 IEC 61000-4-6 Micro-cuts and voltage fluctuation IEC 61000-4-11
standards	EN/IEC 60947-4-2
product certifications	B44.1-96/ASME A17.5 for starter wired to the motor delta terminal CCC CSA C-Tick GOST UL
IP degree of protection	IP20
pollution degree	2 EN/IEC 60947-4-2
vibration resistance	1.5 mm peak to peak 3...13 Hz EN/IEC 60068-2-6 1 gn 13...150 Hz EN/IEC 60068-2-6
shock resistance	15 gn 11 ms EN/IEC 60068-2-27
relative humidity	5...95 % without condensation or dripping water EN/IEC 60068-2-3
ambient air temperature for operation	-10...40 °C without derating 40...50 °C with current derating of 2 % per °C
ambient air temperature for storage	-25...70 °C EN/IEC 60947-4-2
operating altitude	<= 1000 m without derating > 1000 m with current derating of 2.2 % per additional 100 m

## Contractual warranty

Warranty period	18 months
-----------------	-----------

## Dimensions

### Mounting on Symetrical (35 mm) Rail

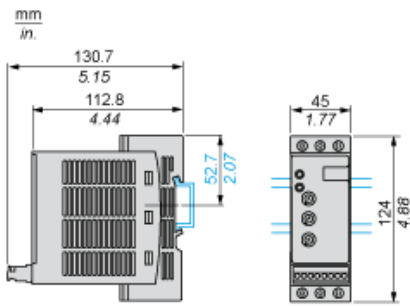

### Screw Fixing

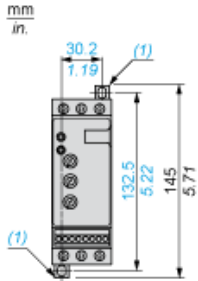

(1) Retractable fixings

### Example of Manual Control

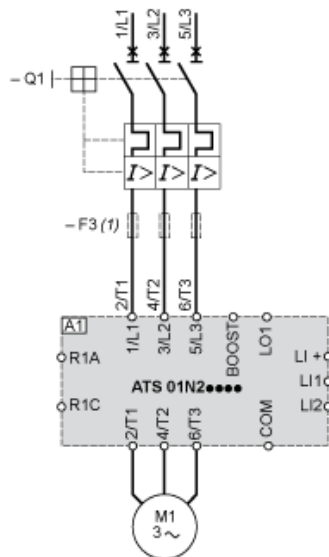

A1 : Soft start/soft stop unit

(1) For type 2 coordination

Q1 : Motor circuit-breaker

F3 : 3 fast-acting fuses

### Function Diagram

#### 2-wire Control with Deceleration

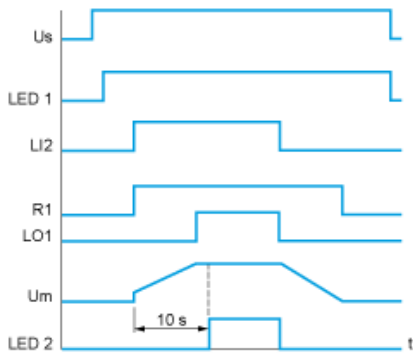

Us : Power supply voltage

LED Green LED

1 :

LI2 : Logic input

R1 : Relay output

LO1 :Logic output

LED Yellow LED

2 :

### 3-wire Control with Deceleration

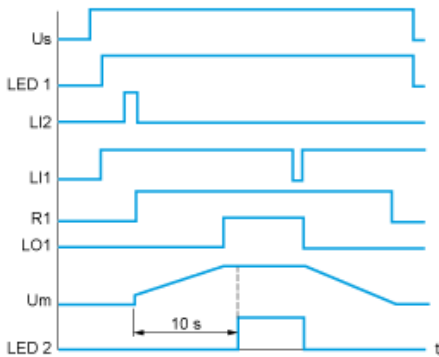

Us : Power supply voltage

LED Green LED

1 :

LI2, Logic inputs

LI1 :

R1 : Relay output



LO1 :Logic output

Um :Motor voltage

LED Yellow LED

2 :

### Our Proposal: Circuit Breaker + Contactor + Soft Starter for Motor Power 4 kW and 380 VAC

Motor Power (kW)	Icu (kA)	Breaker	Contactor (*)	Motor Starter
4	> 100	 GV2ME14	 LC1K0910P7	 ATS01N209QN

Non contractual pictures.

(\*) You can select the contactor proposed or variants. Please consider examples hereafter or follow the link to the complete offer.

Motor Power kW	Coil voltage VAC - 50/60 Hz	24	48	110	115	220	230	400	Other
4	LC1K0910 ..	B7	E7	F7	FE7	M7	P7	V7	Complete Offer

Motor Power	Coil voltage	24	48	Other

<b>kW</b>	<b>VDC - U 0.75...1.25 Uc</b>			
4	LP1K0910 ..	BD	ED	Complete Offer
<b>Motor Power kW</b>	<b>Coil voltage Low Consumption VDC - U 0.8...1.25 Uc</b>	<b>24</b>	<b>110</b>	<b>Other</b>
4	LP4K0910 ..	BW3	FW3	Complete Offer