

# UNI-T®



P/N:110401102684



**UT321/322  
UT323/325  
Operating Manual**

**Digital  
Thermometers**

### Table of Contents

Title	Page
Safety Information	4
Getting Started	7
Components	8
Display Elements	10
Buttons	12
Using the Thermometer	16
Changing Setup Options	16
Entering and Exiting Setup	17
Changing the Logging Interval	17
Changing the Thermocouple Type	18
Changing the Offset (T1)	18
Changing the Offset (T2)	18
Sleep Mode	19
Changing the Line Frequency	19
Setting the Time	19
Setting the Low Limit Alarm (Lo)	20
Setting the High Limit Alarm (Hi)	21

<b>Title</b>	<b>Page</b>
Enabling or Disabling Over Limit Signal Output	23
Enabling or Disabling Normal Temperature Compensation (NTC)	23
Enabling or Disabling Debug	24
Measuring Temperatures	25
Connecting a Thermocouple	25
Displaying Temperatures	26
Holding the Displayed Temperatures	26
Turning on and off of display backlight	26
Viewing the MIN, MAX, and AVG Readings	26
Using the Offset to Adjust Probe Errors	27
Over Limit Alarm	27
Over Limit Signal Output	27
Debug	28
Using Memory	29
Starting and Stopping Logging	29
Viewing Logged Readings	30
Clearing Memory	31
Communicating with a PC	31

<b>Title</b>	<b>Page</b>
Maintenance-----	32
Replacing the Battery-----	32
Cleaning the Case-----	32
Specifications-----	33
Environmental-----	33
General-----	33
Electrical-----	33

### Safety Information

The Uni-Trend Model UT321, UT322, UT323 and UT325 Thermometers (‘the thermometer’) are microprocessor-based, digital thermometers designed to use external J-, K-, T-, E-, R-, S- and N- type thermocouples (temperature probes) as temperature sensors.

- UT321: T1, suitable for K-, J-, T- and E- type thermocouples
- UT322: T1 and T2, suitable for K-, J-, T- and E- type thermocouples
- UT323: T1, suitable for K-, J-, T-, E-, R-, S- and N- type thermocouples. Equipped with over limit alarm, over limit signal output and user self-debug features.
- UT325: T1 and T2, suitable for K-, J-, T-, E-, R-, S- and N- type thermocouples. Equipped with over limit alarm, over limit signal output and user self-debug features.

Use the thermometer only as specified in this manual. Otherwise, the protection provided by the meter may be impaired.

Refer to safety information in Table 1 and the international symbols in Table 2.

Table 1. Safety Information

### **Warning**

A warning identified conditions and actions that pose hazards to the user. To avoid electrical shock or personal injury, follow these guidelines:



- Before using the thermometer inspect the case. Do not use the thermometer if it appears damaged. Look for cracks or missing plastic. Pay particular attention to the insulation around the connectors.
- Disconnect the thermocouple(s) from the thermometer before opening the case.
- Replace the batteries as soon as the battery indicator () appears. The possibility of false readings can lead to personal injury.
- Do not use the thermometer if it operates abnormally. Protection may be impaired. When in doubt, have the thermometer serviced.
- Do not operate the thermometer around explosive gas, vapor, or dust.
- Do not apply more than the rated voltage, as marked on the thermometer (30V), between the thermocouple(s), or between any thermocouple and earth ground.
- When potential differences are anticipated between the thermocouples, use electrically insulated thermocouples.
- When servicing the thermometer, use only specified replacement parts.
- Do not use the thermometer with any part of the case or cover removed.

### Caution

A caution identifies conditions and actions that may damage the meter or the equipment under test.

- Use the proper thermocouples, function, and the range of your thermometer.
- When carrying two thermocouples measurement, make sure there are no potential differences between two thermocouples.
- Do not attempt to recharge the battery.
- Match the + and – polarities of the battery with the battery case.

Table 2. International Symbols

	Refer to the manual for information about this feature
	Complies with European Union directives
	Battery

### Getting Started

Everything in this Users Manual applies to all Models of UT321, UT322, UT323 and UT325 unless otherwise indicated.

To become familiar with the thermometer, study the following:

- Figure 1 and Table 3 describe the components
- Figure 2 and Table 4 describe the display.
- Figure 3-a and 3-b and Table 5 describes the functions of the buttons.

Then read the following sections.



### Components

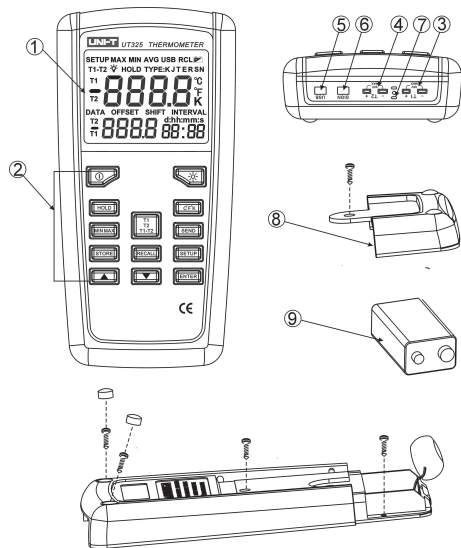

Figure 1. Components

Table 3. Components

①	Display
②	Buttons
③	Thermocouple T1 input
④	Thermocouple T2 input (UT323 and UT325 only)
⑤	USB Port
⑥	SIGN Port - Over Limit Signal Output (UT323 and UT325 only)
⑦	NTC
⑧	Battery Door
⑨	9V battery (6F22 )

### Display Elements

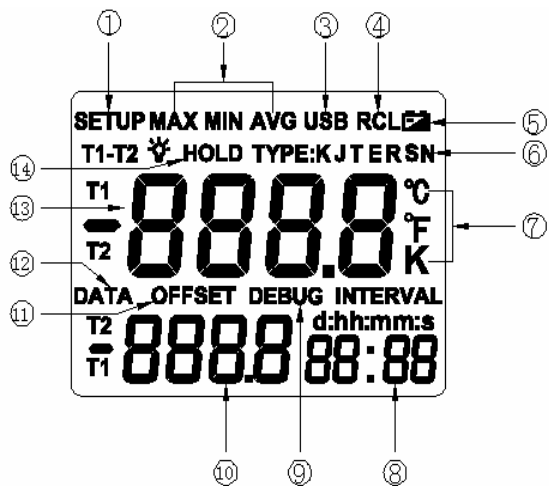



Figure 2. Display Elements

Table 4. Display Elements

①	Setup is in progress when the icon blinks
②	Display readings of maximum, minimum and average
③	Data Transferring is in progress
④	Logged readings are displayed when the icon blinks
⑤	Low battery. Replace the battery
⑥	The thermocouple type
⑦	The temperature units
⑧	Secondary Display 1
⑨	Under Calibration mode when the icon blinks. The displayed reading is fixed.
⑩	Secondary Display 2
⑪	The thermocouple measurement includes an offset. See "Changing Setup Options"
⑫	Readings are being logged when the icon blinks
⑬	Primary Display
⑭	The displayed readings do not change
	The symbol of display backlight

### Buttons

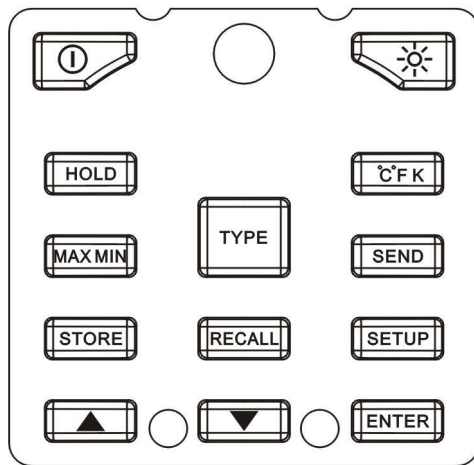

Figure 3-a UT321 and UT323 buttons set

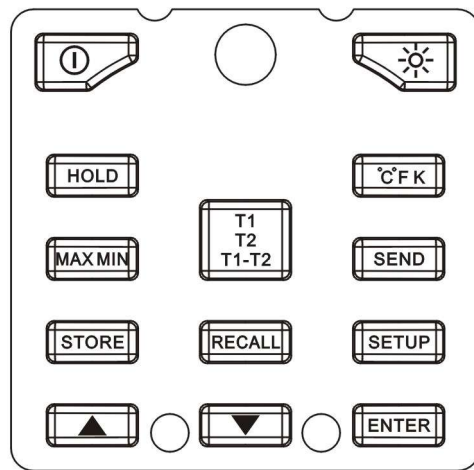

Figure 3-b UT322 and UT325 button set

Table 5. Buttons





	Press to turn the thermometer on or off
	Press to turn the display backlight on and off.
<b>HOLD</b>	Press to freeze or unfreeze the displayed readings
°C °F K	Press to switch between Celsius (°C), Fahrenheit(°F), and Kelvin (K)
<b>MAX MIN</b>	Press to step through the maximum, minimum, and average readings. Press and hold to turn off this display.
<b>TYPE</b> (UT321/UT323)	Press to step through K-, J-, T-, E- (R-, S-, N-) type thermocouple.
T1 T2 T1-T2 (UT322/UT325)	Press to toggle showing the T1, T2 and T1-T2 (differential temperature measurement) in the primary or secondary display 1
<b>SEND</b>	Press to enter USB mode and the USB icon blinks. Press again to exit USB mode.
<b>STORE</b>	Press to start or stop logging. (See “Using Memory - Starting and Stopping Logging”.)
<b>RECALL</b>	Press to show logged readings Press again to stop.

Table 5. Buttons

<b>SETUP</b>	Press to start or exit Setup. Press to scroll the Setup option you want to change (See “Changing Setup Options”)
	After entering the Setup mode, press to increase the displayed setting. (See “Changing Setup Options”)
	After entering the Setup mode, press to decrease the displayed setting. (See “Changing Setup Options”)
<b>ENTER</b>	Confirm button. (See “Changing Setup Options”)



### Using the Thermometer

- 1) Plug the thermocouple(s) into the input connector(s).
- 2) Press the power button to turn on the thermometer.
- 3) Set the type of thermocouple(s) to be same of the type plug into the input connector(s).

If no thermocouple is plugged into the selected input or the thermocouple is “open” and the over-range positive deviation is too big, the display shows “\_ \_ \_ \_”.

### Changing Setup Options

- Use Setup to change the following settings:
- Logging interval → Thermocouple type → Offset (T1) → Offset (T2) (UT322 and UT325 only) → Sleep Mode → Line Frequency → Time (S-T) → Low Limit Alarm (Lo) (UT323 and UT325 only) → High Limit Alarm (Hi) (UT323 and UT325 only) → Over Limit Signal Output (SI) ON/OFF → (UT323 and UT325 only) Normal Temperature Compensation (NTC) ON/OFF → DEBUG ON/OFF (UT323 and UT325 only) → Save setting and return to normal measurement mode.

### *Entering and Exiting Setup*

When the thermometer is in Setup mode, the display shows and blinks SETUP.

- Press **SETUP** to start or exit Setup.
- Press **SETUP** to scroll the Setup option you want to change after

### *Changing the Logging Interval*

The logging interval determines how often the thermocouple stores logged readings in memory. You choose the length of the logging interval. See “Using Memory”.

Press **SETUP** until the display shows INTERVAL.

The thermometer stores logged readings at the end of each logging interval. You can select a logging interval by pressing ▲ or ▼. Holding down ▲ or ▼ causes the number to change more quickly. The maximum interval is 59:59 and the minimum interval is 00:00. When the logging interval is 00:00, you need to store the readings manually as the auto store feature will be disabled.

### ***Changing the Thermocouple Type***

1. Press **SETUP** until the display shows TYPE.
2. Press **▲** or **▼** to select the thermocouple type you want including K-, J-, E- type (UT323 and UT325 have extra R-, S- and N- type).

### ***Changing the Offset (T1)***

1. Press **SETUP** until the display shows OFFSET and T1
2. Press **▲** or **▼** until the display shows the correct reading. The offset readings range

### ***Changing the Offset (T2)***

1. Press **SETUP** until the display shows OFFSET and T2
2. Press **▲** or **▼** until the display shows the correct reading. The offset readings range

### ***Sleep Mode***

1. Press **SETUP** until the display shows SLP.
2. Press **▲** or **▼** as need until the display shows the correct sleep mode time you want, it is between 5~60 minutes.
3. Holding down **▲** or **▼** causes the time to change more quickly.
4. When the sleep mode time is less than 5 minutes, the display shows OFF which means disabling the sleep mode.

### ***Changing the Line Frequency***

1. Press **SETUP** until the display shows LINE.
2. Press **▲** or **▼** to select 60Hz or 50Hz.

### ***Setting the Time***

1. Press **SETUP** until the display shows S-T.
2. Press **ENTER** to toggle between minutes: second (m:s) and hour: minutes (h:m).
3. Press **▲** or **▼** until the display shows the correct time. The time is 24- hour format.
4. Holding down **▲** or **▼** causes the number to change more quickly.
5. The system time is the current meter running time if there is no changing on this setup option.

6. The system time is counted when the user turning on the thermometer. It zeros automatically when the electricity is cut.

### ***Setting the Low Limit Alarm (Lo) ((Only UT323 and UT325)***

1. Press **SETUP** until the display shows Lo.
2. Press **▲** or **▼** until the display shows the correct low limit alarm.
3. Holding down **▲** or **▼** causes the number to change more quickly
4. Press **ENTER** to turn the low limit alarm off, the display shows OFF. Press **ENTER** again to turn the low limit alarm on, the display shows the low limit alarm reading.
5. When the tested temperature is over the limit, the thermometer beeps
6. The minimum reading of low alarm is the minimum measuring range of each type of thermocouple,
7. The maximum reading of the low alarm is either the high alarm reading minus 1 or the maximum reading of measuring range of each type of thermocouple. .  
For example:
  - The minimum reading of the low alarm of K type is -200°C.
  - The maximum reading of the low alarm of K type is either the high alarm reading minus 1 or +1372°C

Below table shows the measuring range of each type of thermocouple

K type: -200.0°C to +1372°C (-328.0 °F to +2501 °F)
J type: -210.0°C to +1200°C (-346.0 °F to +2192 °F)
T type: -250.0°C to +400.0°C (-418.0 °F to +752.0 °F)
E type: -150.0°C to +1000°C (-238.0 °F to +1832 °F)

### ***Setting the High Limit Alarm (Hi) (Only UT323 and UT325)***

1. Press **SETUP** until the display shows Hi..
2. Press **▲** or **▼** until the display shows the correct high limit alarm.
3. Holding down **▲** or **▼** causes the number to change more quickly
4. Press **ENTER** to turn the high limit alarm off, the display shows OFF. Press **ENTER** again to turn the high limit alarm on, the display shows the high limit alarm reading.
5. When the tested temperature is over the limit, the thermometer beeps
6. The maximum reading of high alarm is the maximum measuring range of each type of thermocouple,
7. The minimum reading of the high alarm is either the low alarm reading plus 1 or the minimum reading of measuring range of each type of thermocouple. .

For example:

- The maximum reading of the high alarm of K type is +1372°C.
- The minimum reading of the high alarm of K type is either the low alarm reading plus 1 or -200°C.

Below table shows the measuring range of each type of thermocouple

K type: -200.0°C to +1372°C (-328.0°F to +2501°F)
J type: -210.0°C to +1200°C (-346.0°F to +2192°F)
T type: -250.0°C to +400.0°C (-418.0°F to +752.0°F)
E type: -150.0°C to +1000°C (-238.0°F to +1832°F)

### ***Enabling or Disabling Over Limit Signal Output (Only UT323 and UT325)***

1. Press **SETUP** until the display shows SI.
2. Press **▲** or **▼** to turn the over limit signal output on or off. The display shows on or off.
3. After setting the high or low limit alarm and turning on the over limit signal output, the SIGN port of the thermometer will output the corresponding signal if the tested temperature is over or under the high or low limit. When the tested temperature is over the high limit, the SIGN port will output the high electric level signal. When the tested temperature is under the low limit, the SIGN port will output around 10Hz pulse signal.

### ***Enabling or Disabling Normal Temperature Compensation (NTC)***

1. Press **SETUP** until the display shows NTC.
2. Press **▲** or **▼** to turn normal temperature compensation on or off. The display shows



### *Enabling or Disabling Debug (Only UT323 and UT325)*

1. Press **SETUP** until the display shows DEBUG.
2. Press **▲** or **▼** to turn Debug on or off. The display shows on or oFF. The thermometer is default as oFF.
3. You can self-debug the thermometer when the Debug feature is turned on. (Refer to Measuring Temperatures – Debug)

## Measuring Temperatures

### *Connecting a Thermocouple*

Thermocouples are colour coded by type based on the North American ANSI Colour Code:

Type	Colour	Type	Colour
J	Black	R	Green
K	Yellow	S	Green
T	Blue	N	Orange
E	Purple		

1. Plug a thermocouple into the input connector(s).
2. Set the thermometer for the correct thermocouple type.  
To change the thermocouple type, see “Changing Setup Options”.



### ***Displaying Temperatures***

1. Press °C °FK to select the correct temperature scale.
2. Hold or attach the thermocouple(s) to the measurement location.  
The temperature reading appears in the selected display

### ***Holding the Displayed Temperatures***

1. Press **HOLD** to freeze the readings on the display. The display shows HOLD.
2. Press **HOLD** again to turn off the HOLD function.

### ***Turning on and off of display backlight***

1. Under temperature measurement mode, press  to turn the display backlight on.
2. Press  again to turn off the display backlight. The display backlight will not automatically off.

### ***Viewing the MIN, MAX, and AVG Readings***

1. Press **MIN MAX** to step through the maximum (MAX), minimum (MIN), or the average (AVG) readings.
2. Press and hold **MIN MAX** to exit MIN MAX mode.

### ***Using the Offset to Adjust for Probe Errors***

Use the offset option in Setup to adjust the thermometer's readings to compensate for the errors of a specific thermocouple.

1. Plug the thermocouple into the input connector.
2. Place the thermocouple in a known, stable temperature environment (such as an ice bath or a dry well calibrator).
3. Allow the readings to stabilize.
4. In Setup change the offset until the display reading matches the calibration temperature. (See "Changing Setup Options.")

### ***Over Limit Alarm (Only UT323 and UT325)***

Setting the low alarm and high alarm limit at the SETUP mode, the thermometer beeps when the measured temperature is higher or lower than the pre-set limit. (See "Changing Setup Options.")

### ***Over Limit Signal Output (Only UT323 and UT325)***

Setting the low and high limit signal output at the SETUP mode, the SIGN port output the corresponding signal when the measured temperature is higher or lower than the pre-set limit. (See "Changing Setup Options.")

### ***Debug (Only UT323 and UT325)***

After entering the Debug mode, you can self-debug. Below is the procedure:

- ***Debug point:***

K- and J- type:	-180°C, 0°C and 900°C
T type:	-180°C, 0°C and 400°C
E type:	-140°C, 0°C and 900°C
R- and S- type:	0°C and 1200°C
N type:	-180°C, 0°C and 1200°C
Remark:	0°C only need to debug k type.

- ***Debug method:***

1. Connect T1 and T2 to standard voltage source.
2. Standard voltage source input the corresponding voltage of debug point.
3. Press **HOLD** to freeze the debug data.
4. Normal Temperature debug:  
Press **MAX MIN** when the thermometer is at Debug mode, secondary display 1 shows the offset reading.  
Secondary display 2 shows the normal temperature.  
Press **▲** or **▼** to adjust the offset reading, the offset range is -6~+6.

**Remark:**

The corresponding table between temperature and voltage refer to BS EN 60584-1:1996. Before carrying out debug, to ensure your standard source has enough accuracy. It is at your own responsibility, if the thermometer has too big accuracy deviation is caused by the standard source does not have enough accuracy.

## Using Memory

During a logging session, the thermometer stores logged readings in its memory.

The thermometer stores 00-99, total 100 sets of temperature readings. The stored readings are from primary display.

### *Starting and Stopping Logging*

1. Set the logging interval. (See “Changing Setup Options.”)
2. Press **STORE** to start logging.  
The display blinks DATA.
3. Press **STORE** again to stop logging.
4. If you selected a manual logging interval, set the logging interval as 00:00. Press **ENTER** each time you want to store logged readings in memory. The secondary

- display 1 shows the logged reading. Each presses of **ENTER** will automatically store the logged readings in the next memory location. Press **▲** or **▼** could change the memory location, the empty location shows “- - - -”.
5. If you selected an auto logging interval, set the logging interval not 00:00. After entering logging mode, the secondary display 2 shows “:” Press **ENTER** to start storing readings in sequence according to the pre-set logging interval, the “:” blinks. Press **ENTER** again to pause auto logging, the “:” stop blinking. Press **ENTER** again to resume logging, the “:” blinks again.

### ***Viewing Logged Readings***

1. Press **RECALL** to view logged readings.  
The display shows RCL and blinks.
2. Press **▲** or **▼** to scroll through the logged readings, the default reading is the last stored reading when exiting the logging. The recalled reading will automatically toggle to the measurement unit when logging.
3. The logged readings will automatically toggle to the temperature unit during logging.
4. The secondary display 1 shows its memory location. The secondary display 2 shows its time stamp. The primary display shows each logged reading.
5. Press **ENTER** causes the readings to change more quickly until memory location reaches 99.

### ***Clearing Memory***

1. Press **STORE** to enter logging mode, the display shows DATA and blinks.
2. Press and hold down **STORE** 2 seconds, the display shows CLR.
3. Press **ENTER** to delete all the logged readings from memory. It is not possible to delete the logged readings one by one.  
The display then shows "----"

### **Communicating with a PC**

You can transfer the contents of the thermometer's memory to a PC using the included Software.

Press **SEND** button and USB blinks on the display. It means the thermometer and the PC are connected correct. Details refer to the Installation Guide file in the Software.

Under the influence of radiated Radio-Frequency electromagnetic Field phenomenon, the captioned model have a measurement error, it will be back to normal when the interference is removed.



### **Maintenance**

#### ***Replacing the Battery***

Replace the batteries as soon as the battery indicator  appears. The possibility of false readings can lead to personal injury.

1. Turn off the thermometer.
2. Loosen the screw and remove the battery door.
3. Replace 1 piece of 9V battery (6F22). Replace the battery door and tighten the screw.

#### ***Cleaning the Case***

Use soap and water or mild commercial cleaner. Wipe with a damp sponge or soft rag.

### Specifications

#### *Environmental*

Operating Temperature	-10°C to 50°C (14°F to 122°F)
Storage Temperature	-40°C to + 60°C (-14°F to +140°F)
Humidity	Non condensing <10°C (<50°F) 95% RH: 10°C to 30°C (50°F to 86°F) 75% RH: 30°C to 40°C (86°F to 104°F) 45% RH: 40°C to 50°C (104°F to 122°F)

#### *General*

Certification	CE
Safety	EN61326: 2006, EN55022: 2006 and EM55024: 1998+A1+A2

### Electrical

Function	UT321	UT322	UT323	UT325	Input Protection
Type	K, J, T, E		K, J, T, E, R, S, N		30V
Input	T1	T1, T2	T1	T1, T2	
Measurement Range	K type: -200.0°C to +1372°C (-328.0 °F to +2501 °F)				
	J type: -210.0°C to +1200°C (-346.0 °F to +2192 °F)				
	T type: -250°C to +400.0°C (-418 °F to +752.0 °F)				
	E type: -150.0°C to +1000°C (-238.0 °F to +1832 °F)				
Display Resolution	0.1°C °F/K.... (<1000) (T type below -200°C and R type, S type is 1°C °F/K) 1.0°C °F/K.... (>1000)				
Measurement Accuracy	±(0.5%+0.8°C(1.6°F))		K-,J-,T-, E- type: ±(0.2%+0.6°C(1.2°F))		
			R,S type: ±(0.2%+2°C(4°F))		
			N type: ±(0.2%+1.5°C(3°F))		

## Model UT321/322/323/325: OPERATING MANUAL

Function	UT321	UT322	UT323	UT325	Input Protection
Measurement Accuracy	Below -10°C: add 0.5°C Below -200°C, add +2°C Type T Below -200°C: for reference only.				30V
Sampling Rate	50 times per second, Updates 2-3 times per second				
Time	Relative Time				
Data Store	0 ~ 99 sets				
Setup	Logging Interval, Thermocouple Type, Offset (T1), Offset (T2) (UT322 and UT325 only), Sleep Mode, Line Frequency, Time, High/Low Limit (UT323 and UT325 only), Over Limit Signal Output (UT323 and UT325 only), Normal Temperature Compensation, Debug (UT323 and UT325 only)				
Over Limit Alarm	N/A		Yes		
Over Limit Signal	N/A		Yes		
Power	One piece of 9V (NEDA1604 or 6F22 or 006P)				

Accuracy is specified for ambient temperatures between 18°C(60°F)and 28°C (82°F) for a period of 1 year, operating temperatures: -10°C ~ 50°C (14°F ~122°F). The above specifications do not include thermocouple error,probe tolerance is not included in above technical index.

\*\* END \*\*

Manufacturer:  
Uni-Trend Technology (China) Limited  
Dong Fang Da Dao  
Bei Shan Dong Fang Industrial Development District  
Hu Men Town, Dongguan City  
Guang Dong Province  
China  
Postal Code: 523 925

Headquarters:  
Uni-Trend Group Limited  
Rm901, 9/F, Nanyang Plaza  
57 Hung To Road  
Kwun Tong  
Kowloon, Hong Kong  
Tel: (852) 2950 9168  
Fax: (852) 2950 9303  
Email: [info@uni-trend.com](mailto:info@uni-trend.com)  
<http://www.uni-trend.com>